



Security Solutions



*Service and Quality
for your Protection*

Company Profile



CERTIFICATE NO. NAC/G/60



CERTIFICATE NO. FIR/G/60



Capstan Security was formed in 1978 with the objective to provide our customers with quality products, system designs, installations, service and value.

At Capstan we always believe that first impressions are important and our attention to detail coupled with a proven ability to install and maintain systems efficiently, have been the key to our success.

To this end our experienced Security Surveyors are able to offer a complete range of Banham Security products including Banham's unique key registration system.

Our advice is entirely free of obligation.

Capstan Security is proud to receive the Metropolitan Police Gold Alarm Performance Award.

PROTECTING
YOUR
PROPERTY
24•7





Security recommendations and checklist

4



Intruder alarms

6



Alarm Receiving centre and keyholder services

8



Fire alarms and fire protection

11



Door entry, access control and CCTV

13



Door Locks

17



Window Locks

23



Grilles, gates and shutters

28



Safes

33



Gun cabinets

35

Security recommendations

This guide gives you an overview of Capstan's comprehensive product range.

Statistics prove that by taking quite simple, relatively inexpensive precautions you can deter the would-be intruder(s), the majority of whom are opportunistic sneak-thieves. It is of course necessary to take extra precautions to keep out the professional burglar but remember that security buys you time, something the intruder does not have.

The list below will help you to decide what steps you need to take to protect your premises.

All locks are insurance approved and are fitted in conjunction with Banham.

- **FRONT DOOR** - should have a BS3621 Kitemarked 5, 6 or 7 lever mortice lock or cylinder mortice lock together with a cylinder rim deadlock also to BS3621.
- **SIDE & BACK DOORS** - fit a 5,6 or 7 lever BS3621 mortice lock together with top and bottom security bolts.
- **WINDOWS** - windows are most vulnerable to forced entry, especially at the rear of the house. Fit window locks to all ground and upper floor windows where necessary particularly where there is a flat roof or drainpipe etc.
- **FRENCH WINDOWS & PATIO DOORS** - fit appropriate key-operated locks to the top, bottom and centre (if necessary) of doors.
- **OUTBUILDING & GARAGES** - often contain garden equipment etc that would be useful to a burglar, so ensure they are secured by a suitable mortice lock or padlock.

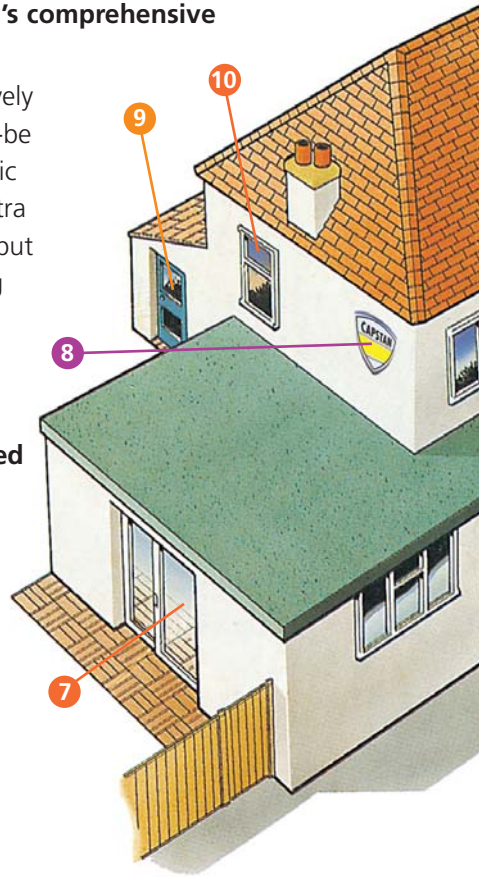

- **INTRUDER ALARMS** - the installation of a simple intruder alarm with the deterrent value of a strategically located external siren cover bearing the Capstan name, with pulsing lights incorporated to provide clear indication of a live and fully functional system. Designed and installed to be fully compliant with the ACPO policy, DD243 and European Standard EN 50131-1:2006 /PD6662 for Intruder Alarm installations.

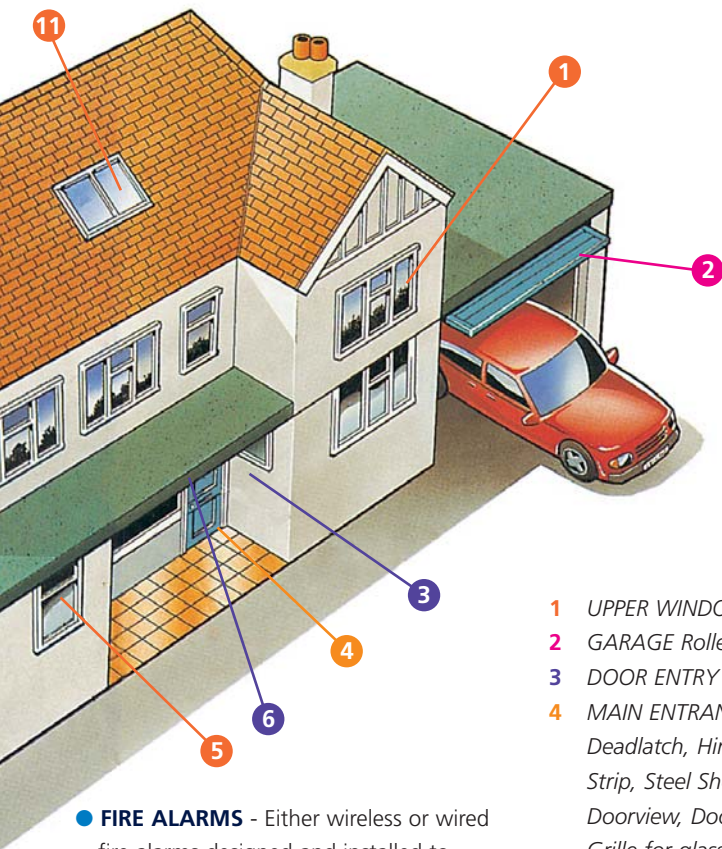

- **FIRE ALARMS** - Either wireless or wired fire alarms designed and installed to comply with BS 5839:2002 Part 1 & 6 or fixed detection devices simply connected into your intruder alarm system.

- **FIRE EXTINGUISHERS**

- **CCTV & DOOR ENTRY SYSTEMS** - suitable for both domestic and commercial situations.

- **ALARM RECEIVING CENTRE** - provides 24-hour monitoring for all types of alarm systems.

- **KEYHOLDING / ALARM RESPONSE SERVICE** - for domestic and commercial properties.

- 1 UPPER WINDOWS Locks, Grilles.
- 2 GARAGE Roller doors with remote control.
- 3 DOOR ENTRY SYSTEM
- 4 MAIN ENTRANCE Mortice lock, Security Deadlatch, Hinge Bolts, Steel Reinforcing Strip, Steel Sheet, Anti-Bandit Gate, Doorview, Door Chain, Door Entry System, Grille for glass area, Alarmed Keypad Control.
- 5 GROUND FLOOR WINDOWS Locks, Grilles, Collapsible Gates.
- 6 CCTV
- 7 FRENCH DOORS Locks, Grilles, Collapsible Gates, Continental Shutters.
- 8 ALARM SYSTEM
- 9 SIDE & BACK DOORS Mortice Locks, Grilles, Hinge Bolts.
- 10 UPPER WINDOWS (accessible from flat roof adjoining property, drain pipe etc) Locks, Grilles, Collapsible Gates.
- 11 ROOF LIGHT Locks, Grilles.

Intruder Alarms



- We offer a range of alarm systems to suit small private properties right through to larger domestic and commercial installations.
- Equipment is individually specified and easy to use.
- Clear indications are made via a large display and comprehensive digital keypad in order to operate the system.
- Alternatively operation with a keyswitch or keyfob.
- All installations comply with European Standard EN 50131-1:2006/PD6662 and the requirements laid down by the National Security Inspectorate (NSI).



CERTIFICATE NO. NAC/G/60



We guarantee not to raise the annual maintenance and monitoring charges above the annual rate of inflation, and offer a lifetime guarantee on any system connected to the alarm receiving centre on a full police monitored contract.

For further detailed information on our alarm systems, please ask for our intruder alarm brochure.

The new Capstan Euro One

AUTOMATIC REMOTE MAINTENANCE (ARM)

Using ARM our service department can verify that your entire security system is fully functional down to the last 'nut and bolt', giving you complete confidence and peace of mind in your security arrangements.

SECURE AND CONVENIENT

ARM enhances your security by constantly checking on the electrical status and functional capability of your alarm system. Regular reporting by your alarm system to Capstan takes the hassle out of service visits and ensures it is always operating at its peak performance level.

FULL SIGNALLING AND WARNING ANALYSIS

The correct operation of signalling equipment to the alarm receiving centre is reassured, along with a full test of the external sounders, initiated by the user.

DETECTOR PERFORMANCE ANALYSIS

All detectors are regularly checked to ensure your complete protection. Regular reminders to walk-test the system are given.

FORMAL REPORTING

At a pre-set time, the control panel will call the service desk and upload a full report on the status of your system. This report may be printed and copied to you, if required.

DD243 AND EN50131

ARM software incorporates the very latest technology to conform with the current police and European requirements on false alarm reduction.

Alarm Receiving Centre (ARC)

Capstan provides 24 hour monitoring for all types of alarm systems, including

- Intruder
- Fire
- Panic
- Freezer
- Medical
- Power Failure
- Disabled People
- Vault
- Opening and Closing Management
- Flood Warning
- Access Control
- Ambient Temperature
- Humidity Level
- Machinery Monitoring
- Controlled Environment Monitoring



Dualcom Vodafone is a dual path communication link between your property and the ARC. The normal landline (from any analogue service provider) and the Vodafone/GSM radio network combine to provide an increased level of security. This is actively promoted by both crime prevention officers and insurance companies alike. The unit requires an aerial, the location of which is subject to an engineer site environment test. Monitoring charges from 75p per day.

Digital Communicator is a single path communication link between your property and the ARC, which can utilise any network provider using either an existing standard analogue line or an exclusive dedicated out-going line for increased security. Monitoring charges from 25p per day.

BT Redcare offers the same features as Digital Communicator but if a line fault occurs, a warning will be displayed in our ARC, which is then subject to keyholder response only unless preceded by an intruder activation. Monitoring charges from under £1.00 per day.

BT RedGSM is connected to your normal BT landline and combines GSM radio technology to provide a dual path communication link between your property and the ARC. The unit requires an aerial, the location of which is subject to an engineer site environment test. RedGSM is recommended by insurance companies where a high level of alarm transmission is required. Monitoring charges from just over £1.00 per day.

24 hour Police Response



MONITORED ALARMS WITH KEYHOLDER RESPONSE ONLY

We also provide a monitored alarm system with keyholder response only. This service also provides added security and peace of mind as clients themselves or their nominated keyholders can be contacted following an alarm activation. This system can be designed to meet the client's requirements subject, where necessary, to their insurer's approval. Temporary monitoring is also an option. For further details of the available options, please contact your Capstan surveyor.



Residential



Business and Offices



Police Response



Keyholding response



Emergency Services



24hr Engineer Response

Wireless Equipment

The Capstan Euro One panel incorporates a wireless option, which provides a combination of both hard-wired and wireless technologies. This can provide a flexible alternative, even in the most highly decorated scenarios, or those of historical importance, where the concealment of unsightly wiring is impossible.



Capstan have found that the introduction of the Wireless range to be an effective compromise between security requirements and aesthetic impact which is welcome by clients.

The Euro One wireless brand has an extremely reliable operational record and has been integrated into the Capstan Product range following successful completion of extensive evaluation in some of the most challenging environments.

Fire Alarms



SMOKE SIREN

FIRE ALARM SOLUTIONS

At Capstan our ability to install and maintain reliable fire detection systems and provide our customers with Fire Security Solutions of the highest standard at competitive rates, without compromising on quality, is the key to our success. So whether you require a new system or your existing fire alarm maintained, you can rely on Capstan.

We can also provide monitoring of your system at our approved Alarm Receiving Centre to provide a response from the Emergency Fire & Rescue Services.



THE LAW

REGULATORY REFORM ORDER 2006

Are you aware of your responsibilities? If you employ five or more people the law has changed. From October 2006 the Regulatory Reform Order transfers Fire Safety responsibility to employers or owners of non domestic premises.



**IONISATION SMOKE
DETECTOR**



MANUAL CALL POINT



FIRE PANEL

ACCREDITATION

Capstan are an accredited NSI Fire Gold company and our Automatic Fire Detection Systems are installed and maintained to comply with BS 5839.

On completion of the system a BAFF/NSI Certificate of Compliance will be issued.

Systems can be monitored by the Capstan Alarm Receiving Centre.

Capstan Fire Solutions

PORTABLE EQUIPMENT

- Portable fire-fighting equipment, conforming to BS EN3: and British Standard 5306:2003 part 3, must be readily accessible, simple to operate and clearly labelled, with designated persons nominated to implement these measures.
- Maintenance must be carried out by a competent engineer trained according to BS Standards, who will ensure that appliances are: sited correctly, fully operational and not damaged.

ARE YOU PROTECTED?

- Every year thousands of people are injured by Fire and Smoke. Although there is no foolproof method to prevent this from happening, Capstan can help make your property a safer place. We install and maintain fire extinguishers as recommended by the Fire Protection Association.



MEMBERS OF
THE BRITISH FIRE CONSORTIUM



*Capstan can maintain all types of fire extinguishers.
For further detailed information please ask for our fire extinguisher leaflet.*

CCTV, Door Entry & Access Control

Capstan Security is an NSI Gold approved Installer for CCTV & Access Control Systems certified to NACP 20 and NACP 30

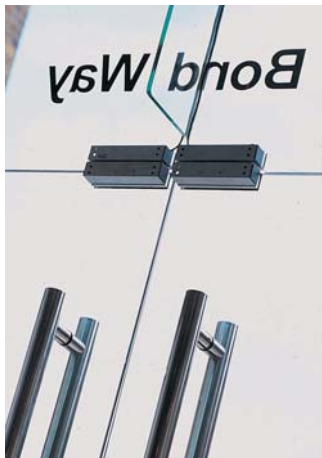

DOOR ENTRY AND ACCESS CONTROL

- Door entry and access control systems can be supplied and fitted in a variety of styles to suit your property.
- Access can be gained using a PIN number or "Swipe Card" instead of the traditional key.
- Such systems are ideal when more flexible control is required in both domestic and commercial situations.



AUDIO ENTRY PHONE



PROXIMITY CARD READER





CLOSED CIRCUIT TELEVISION (CCTV)

- CCTV can be designed, supplied and fitted to suit a wide range of requirements in both domestic and commercial situations.
- CCTV can also be used together with external Security Lighting providing an increased level of security.
- CCTV can be installed to interface with intruder alarm systems to provide uncorruptable digital images of incidents which take place, whether the premises are occupied or not. These images are permissible as evidence in a Court of Law.



**VANDAL RESISTANT
DOME CAMERA**



MONITOR AND HARD DISC RECORDER



DISCREET CAMERA



NIGHT CAMERA

Allows you to control and monitor who enters your premises.



CMS Keyholding

A **BANHAM** Group Company



KEYHOLDING SERVICES

- Keyholding Service for Domestic and Commercial Properties.
- Emergency Response to Alarm Activations.



For further details

LONDON: 020 7627 0344

GUILDFORD & ST ALBANS:

0845 6716011

www.cmskeyholding.com

The Banham Key Registration System

You can feel secure in the knowledge that your keys cannot be copied without your consent.

It is a safeguard that only the persons whose signatures appear on your Banham Key Registration Card are authorised to obtain additional keys from us. In addition we can at any time supply information on the number of keys previously duplicated.

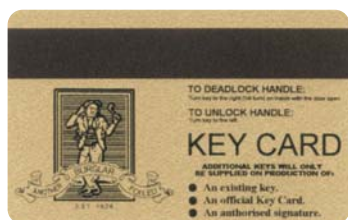

Banham have the most effective key registration system to back up our new patented keys as all Key Registration Cards are scanned into our secure

computer systems ensuring that the information is available electronically at all our branches. Whilst others may purport to offer such a system, Banham offers an exclusive, totally reliable and foolproof system, on the basis that our latest key section is protected by the law of patent. Banham will vigorously defend any breach of their patent in the unlikely event that this should occur.

BANHAM KEY REGISTRATION CARD
 IMPORTANT RETURN THIS PORTION (ORIGINAL COPY ONLY) TO
 BANHAM PATENT LOCKS LTD 10 PASCAL STREET, LONDON SW6 4SH

INVOICE NUMBER: 165432 LS
 NAME (BLOCK LETTERS): Mr M Smith
 ADDRESS: 47 South Road, London
 POSTCODE: SW11 6NZ TEL: 020 7622 5151

REGISTERED KEY NUMBER: 02 55737
 OTHER KEY HOLES IF APPLICABLE: 4
 NO. OF ORIGINAL KEYS: 4
 NUMBER OF GOLD CARDS: 2

PRINCIPAL SIGNATORY: M Smith
 OTHER SIGNATORIES: M Smith

We will only cut keys against the signatures (and printed names) appearing on this card.
 - Unless expressly instructed not to we will cut keys on the written instructions of your property agent.
 Special instructions to Banham (e.g. agent's name)

QTY	DATE	SIGNATURE	FOR SERVICE ON
2	6/3/91	M Smith	
1	2/1/91	M Smith	

Signatures: _____



A2001 Rim Autobolt (Triple locking)

A2001

Dimensions as L2000



- Cylinder and key protected by patent.
- 6 pin drill resistant cylinder.
- Maximum security differs.
- Exclusive coded key registration systems.
- High security 10" striker plate on door frame.
- Saw resistant steel bolt.
- Self deadlocking.
- Can be operated with the same key as Banham M2002/3, padlocks and collapsible gates.
- Automatic self deadlocking bolt which activates 2 extra bolts across the inside of your door.
- Finish: Satin Brass / Chrome and Polished Brass / Chrome.

A2001 STRIKER PLATE

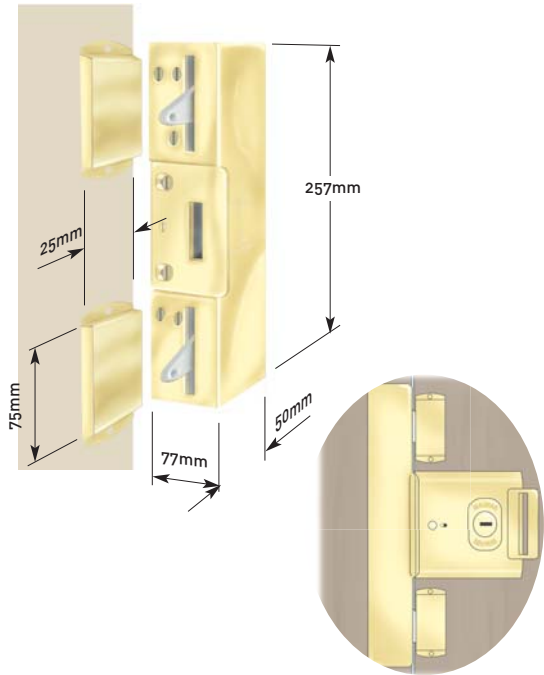

Lock to British Standard 3621, Patented and Insurance approved

L2000 Rim Deadbolt (Strong Staple)

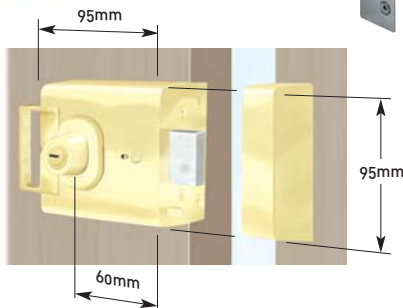

- Cylinder and key protected by patent.
- 6 pin drill resistant cylinder.
- Maximum security differs.
- Exclusive coded key registration systems.
- High security 10" striker plate on door frame.
- Saw resistant steel bolt.
- Self deadlocking.
- Can be operated with the same key as Banham M2002/3, padlocks and collapsible gates.
- Finish: Satin Brass / Chrome and Polished Brass / Chrome.

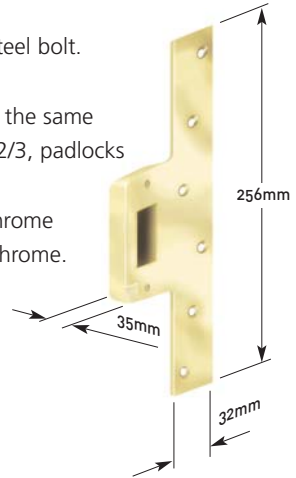

Lock to British Standard 3621, Patented and Insurance approved

EL4000 Rim Deadbolt (With electric release)

Dimensions as L2000



- Cylinder and key protected by patent.
- 6 pin drill resistant cylinder.
- Maximum security differs.
- Exclusive coded key registration systems.
- High security 10" striker plate on door frame.
- Saw resistant steel bolt.
- Self deadlocking latch bolt.
- Can be operated with the same key as Banham M2002/3, padlocks and collapsible gates.
- Finish: Satin Brass / Chrome and Polished Brass / Chrome.

M2002 Cylinder Mortise Deadlock



- Cylinder and key protected by patent.
- 6 pin drill resistant cylinder.
- Maximum security differs.
- Hook Bolt to prevent door being spread.
- Exclusive coded key registration system.
- High security 10" striker plate on door frame.
- Saw resistant steel bolt.
- Security escutcheon plates (to strengthen door).
- Can be operated with the same key as Banham A2001, L2000, padlocks and collapsible gate.
- Available with knob operation on inside to comply with fire regulations (M2003 - see below. Should only be fitted to high security doors).
- Finish: Satin Brass / Chrome and Polished Brass / Chrome.

M2002

Lock to British Standard 3621, Patented and Insurance approved

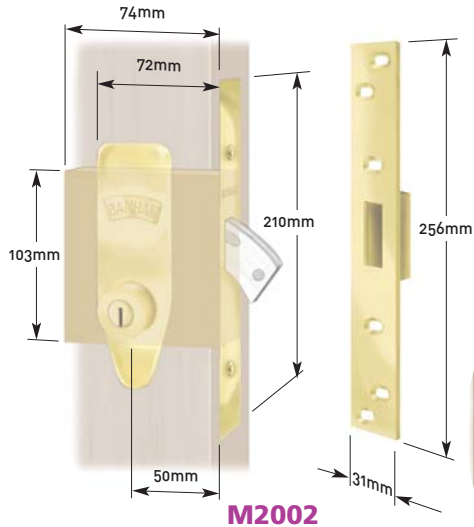

M2002



M2003

M2003

Lock to British Standard 83621, Patented and Insurance approved

M5000 Cylinder Mortise Deadlock



M5000



M5008

M5000 CYLINDER MORTISE DEADLOCK

M5008 (with knob operation)

- Lock specification same as M2002/3 but with Euro Profile cylinder, which can be offset and extended to suit the thickness of the door.

M7 Lever Mortise Deadlock



M7

*Lock to British Standard 3621, Patented and Insurance approved
Approved for use on explosive stores*

- Approved by Health & Safety Executive for use on explosive stores.
- High security seven lever mortise deadlock with maximum security differs.
- High security 10" striker plate on door frame.
- Saw resistant steel bolt.
- Security escutcheon plates (to strengthen door).
- Finish: Satin Brass / Chrome



Additional Security



D100

D100 DOORVUE

- The doorvue incorporates three optically ground convex lenses giving unrestricted vision through the door with a field of view of 170°.
- Finish: Polished Brass / Chrome.

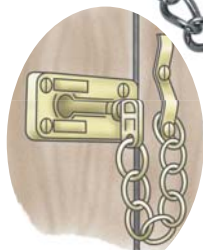

C122

C122 BANHAM DOOR CHAIN

- This door chain is spring loaded to prevent it being slid back when the door is partially open.
- Finish: Finish: Satin Brass / Chrome and Polished Brass / Chrome.

H103 HINGE REINFORCING BOLTS (fitted in pairs)

- These robust bolts are designed to secure the hinge side of the door, and come into operation automatically when the door is closed. A must for all exit doors.



H103

P2005 BANHAM PADLOCK

- Open and close hardened shackle construction ideal for most applications. Operates on the Banham registered key. Key retention ensures the padlock cannot be left open and the key taken out of the cylinder. Padlock body complete with drainage holes to prevent build up of water.



P2005

Concealed Bolts

FOR INTERNAL AND FRENCH DOORS

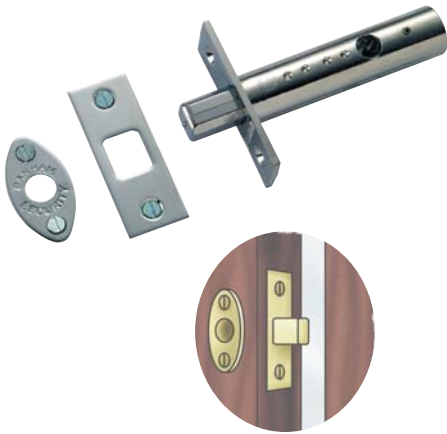

R102

R102 2⁵/₈" (67mm) MORTISE RACK BOLT

- It is suitable for fitting to internal doors or to the top of French doors. Optional fixed or detachable key. This lock can be supplied with 7" (178mm) boxed striker plate embodying a boxed recess as additional protection.
- Finish: Polished Brass / Chrome.



R104

R104 CYLINDER MORTISE RACK BOLT

- The R104 is a more sophisticated version of the R102 and is ideal for fitting to glass panelled doors as it features differing keys. It is also suitable for French doors, cupboards etc. 7" (178mm) boxed striker plate fitted as standard.
- Finish: Polished Brass / Chrome.

Window Locks

FOR SASH WINDOWS



W107

W107 SASH WINDOW LOCK

- This key operated lock enables a window to be locked shut, or open in two positions, thus allowing fresh air to enter while giving protection.
- Finish: Polished Brass.



W121 SASH STOPS

- Enables a window to be locked in open or closed position.
- Finish: Polished Chrome and Satin Brass.

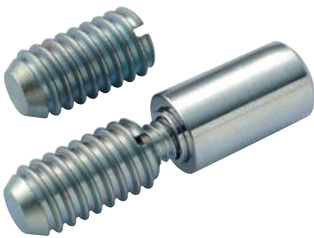

W121



FOR WOOD CASEMENT AND FRENCH WINDOWS



View of top of French door.

W105 1³/₄" (45mm) AND W104 1¹/₄" (30mm) MORTISE RACK BOLTS

- Security bolts for wood casement and wood French windows. Fitted to top and bottom of French door. These security bolts offer protection against the intruder who breaks the glass in order to operate the casement handle.
- Finish: Polished Brass / Chrome / Bronze.



W106 CASEMENT WINDOWS AND FANLIGHT LOCKS

- This lock is specially made for rebated and narrow stile wooden framed casement windows and fanlights. These are at right angles to the reception plate, which is secured into the stile by a heavy fixed thread. When the lock is locked, it tightens the stile to the frame, preventing any play, thus giving the utmost security.
- Finish: Polished Brass / Chrome.

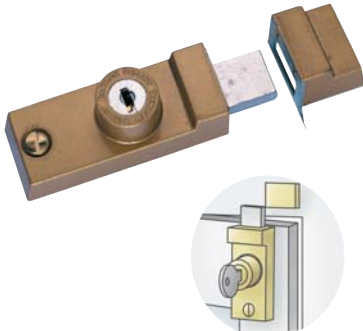

B119 MULTI-PURPOSE BOLT

- Designed to give security to French doors and inward opening casement windows. The multi-purpose bolt incorporates: solid long shoot bolt and cylinder key security.
- Finish: Satin Brass / Chrome.

FOR ALUMINIUM AND METAL WINDOWS



W108 ORIGINAL LOCK FOR ALUMINIUM AND METAL WINDOWS

- This lock is fitted under the handle and flush to the frame by steel screws, the heads being covered when the window is closed.
- Finish: Polished Brass / Chrome.



W109 CYLINDER LOCK FOR METAL WINDOWS

- Suitable for metal casements, fanlights and French doors. Special feature - differing keys.
- This lock has been designed with the concept of maximum security. The locking application is by means of a "U" cam locking on to a hardened steel pin. Works independently from the handle.
- Finish: Polished Brass / Chrome.



W115 DOME SCREW LOCK

- For all types of metal casement windows and fanlights.
- This lock also works independently of the handle, has no accessible fixing screws and has a flush rebate fitting to prevent prising off frame. This lock is also suitable for fanlights.
- Finish: Polished Brass / Chrome.

Door Security



SOLID CORE WOOD SECURITY DOOR

- These doors are laminated with a solid core hardwood centre. They have a 30 minute fire check rating and can have planted mouldings to give a panelled effect.
- Exterior quality, fire resistant, flush doors. 30/30 Rating to BS376 Part 8.

STEEL RE-INFORCEMENT FOR DOORS



Banham Reinforcing Strip

- The Banham steel reinforcing strip is screwed onto the back of the door frame thus considerably strengthening the security. Available for both lock and hinge side.

Banham Steel Sheet

- Banham steel sheet is made from 18 gauge (approx 1/16") galvanised steel bolted through the door with mushroom headed sheet bolts.
- Standard finish for both the above - white. Other colours available on request.



Anti-bandit gate



ANTI-BANDIT GATE & HIGH SECURITY GATE

- Be safe when you open your front door. Banham anti-bandit gate provides an effective barrier to undesirables. The high security version is ideal to withstand a prolonged attack, and comes with its own steel frame and two high security mortise locks.



High security gate

Can operate with same key as your front door.

www.capstansecurity.com

Security Grilles



STRAPPING GRILLES



- Ideal for Georgian type windows.

BARRED GRILLES



- Usually for exterior use.
- Round or square bars



DIAMOND MESH GRILLES

- Mesh size
7" x 2 1/2" 178 x 63mm
3 1/2" x 1 3/4" 89 x 45mm
1 5/8" x 5/8" 42 x 16mm

ORNAMENTAL GRILLES

- 6 styles available.

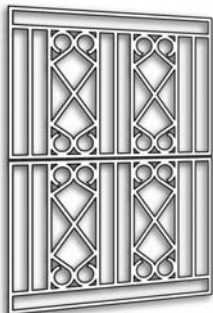

STYLE 1



STYLE 2



STYLE 3



STYLE 4



STYLE 5

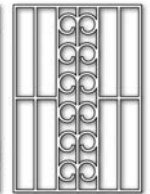

STYLE 6

Grilles are made to measure in our factory and can also be hinged or removable to facilitate window cleaning and emergency exit. Fitted within the window reveal or on the wall surround. Standard finish - White. Other colours available upon request. Designs are subject to width restrictions.



Capstan offer a wide range of steel security grilles for windows and doors.

Collapsible Steel Gates



- Collapsible gates give protection to windows and doors. Manufactured using galvanised steel, with a stove enamelled paint finish, fitted with special Banham security tracking and secured by high security Banham locks which can operate with the same key as the Banham registered door locks and padlocks. The gates can be pushed back out of sight when not in use.
- Standard finish - White. Other colours available on request.
- Can be supplied with lift out or lift up track.

Can operate with same key as your front door.

Steel Roller Shutters

The classic steel roller shutter is ideal for industrial installations for both internal and external applications offering protection against burglary and vandalism. Its galvanised finish adds to its robust construction.

- Available in a powder coated finish
- Perforated slat available
- Can be manually or electrically operated



Continental Shutters



The security shutter range has been developed to provide an aesthetically acceptable answer to the growing need for vandalism and burglary protection for property.

The uniquely neat finish of security shutters, due to the compact aluminium boxes and slim line design offer a tight coiling for a small shutter box. For these reasons Continental Shutters have become a frequent security choice for both commercial and residential properties alike. When fitted, the shutter offers exceptional strength as well as heat and sound insulation, shading, blackout and privacy.

- Suitable for higher security applications
- Available in white / brown and RAL / Bs colours
- Spans widths of up to 5 metres
- Operation can be with a switch or a key switch for added security. A remote control is also available



Combines security protection with privacy.

Roller Garage Doors

INSURANCE APPROVED

Combining great design and exceptional build quality, offering attractive effortless protection for your home. Vertical opening and the benefits of insulation to provide the perfect solution for any single or double garage.

The control unit uses secure state-of-the-art rolling code technology and allows you to operate and lock the door remotely. During a power failure, the door can be operated manually from inside the garage. An optional external override is also available if required



- A Secured by Design Police preferred specification option available tested to LPS 1175
- Vertical opening roller design maximizes drive-through height and saves space
- Double-walled corrosion-resistant aluminium construction is exceptionally strong
- Curtains are fully insulated with CFC-free foam and feature unique brush draught seals to reduce heat loss and sound transmission



- Remote control operation and automatic locking deliver the ultimate in convenience and security
- Receivers come complete with an integral courtesy light and two mini transmitters with high security rolling codes
- Multi-channel version available - controls up to four doors and comes with one transmitter as standard
- Secure comb-locking mechanism ensures the door locks automatically and the curtain is held securely, resisting attempts to lift the door by force.
- Choice of up to nine durable low maintenance factory-coated finishes eliminate the need for painting

Wall Safes



Size 'A' Two Brick



Size 'D' Heavy Duty Three Bolt

Safes and Security Cabinets

- Body 1/4" (6mm) steel plate electric welded seams to give one solid unit.
- Fitted with two adjustable anchor lugs to firmly embed into wall.
- Lock frame machined from 1 1/2" (38mm) solid mild steel.
- Front frames, heavy section solid steel.
- Size D - fitted with four adjustable anchor lugs.
- Door Sizes A, B, C & D. 1/2" (13mm) solid steel plate.
- Size D. Three locking bolts on the front edge.
- Locking into the solid lock frame.
- Drill resistant over entire lock area.
- The door is hung on concealed pivots.
- Door locks. Seven lever keylock supplied with two keys; alternative locking by three wheel keyless combination lock and digital lock.
- All safes can be fitted with micro switches for connection into alarm circuits.

SIZE	WEIGHT	External Measurements H W D	Internal Measurements H W D
'A' <i>(Two Brick)</i>	22.5lbs <i>(10.25kgs)</i>	6" x 9" x 4 3/4" <i>(152mm 229mm 121mm)</i>	5 1/2" x 7 3/4" x 4" <i>(140mm 197mm 102mm)</i>
'B' <i>(Four Brick)</i>	38.5lbs <i>(17.5kgs)</i>	12" x 9 1/4" x 4 3/4" <i>(305mm 235mm 121mm)</i>	11 1/2" x 7 3/4" x 4" <i>(292mm 197mm 102mm)</i>
'C' <i>(Four Brick Double)</i>	45lbs <i>(20.3kgs)</i>	12" x 9 1/4" x 6 1/2" <i>(305mm 235mm 165mm)</i>	11 1/2" x 7 3/4" x 5 3/4" <i>(292mm 197mm 146mm)</i>
'D' <i>(Heavy Duty Three Bolt) fitted with removable shelf</i>	54lbs <i>(24.4kgs)</i>	14" x 12" x 6 1/2" <i>(356mm 305mm 165mm)</i>	13 1/2" x 11 1/2" x 4 5/8" <i>(343mm 292mm 115mm)</i>

Free Standing and Security Safes

Safes and Security Cabinets

- The need for secure storage facilities to protect valuables at home is becoming as important as security in commercial premises, with insurers requiring more and more people to buy safes as a condition of continuing insurance.
- The method of locking is by either key, combination or both, and digital lock.

Fire-Resistant Cabinets

- Banham have an extensive range of fire resistant safes and filing cabinets for storing documents and computer data.

Cash and Deed Boxes

- Banham supply a comprehensive range of secure Cash and Deed boxes.



A complete range of insurance rated safes.

Gun Cabinets

- Strong 2mm thick fully welded steel construction (including welded top)
- Full length anti-jimmy bar
- Full length anti-lever flange and door interlock
- Recessed door with multiple folds on door and door housing
- High density foam divider and floor mat
- Grey textured powder coat finish
- 14mm fixing holes in back and base
- Superior strength 7 lever safe deadlocks
- Extra door reinforcement

SOME IMPORTANT INFORMATION ABOUT GUN CABINETS

- Home Office guidance on gun security can be obtained from the local Police or the Firearms Section, UPPU, Home Office, 50 Queen Anne's Gate, London SW1H 9AT.
- Gun cabinets must be fixed to a brick or concrete wall using a minimum of 4 x 10mm expanding masonry (rawl) bolts.
- They must be out of sight of casual visitors preferably in a room without direct access (i.e., door or window) to the exterior.
- They should not be sited in a garage or external building.
- They should not be marked to show their contents or key numbers.
- Avoid locating them near central heating ducts or chimney stacks as materials, particularly ammunition can be affected by heat or fire.
- Ammunition must be stored in a separate locked compartment.
- For advice on storage of smokeless or black powder (muzzle loading guns) consult an explosives officer.



Guns must be securely locked away at all times.

127 East Barnet Road • New Barnet EN4 8RF
Tel: 020 8441 9700 Fax: 020 8449 5319
Email: sales@capstansecurity.com
www.capstansecurity.com



CERTIFICATE NO. NAC/G/60



CERTIFICATE NO. FIR/G/60

Dec 09